

(5) Connect the vehicle's connector to the connector on the controller (Part ②) and make sure the lamp lights up.

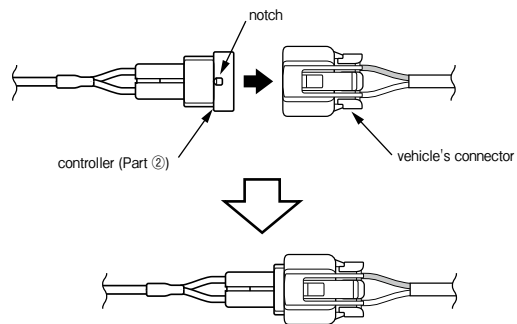

(6) Fix the controller (part②) in place on the vehicle side using the tie wraps provided (part ③).

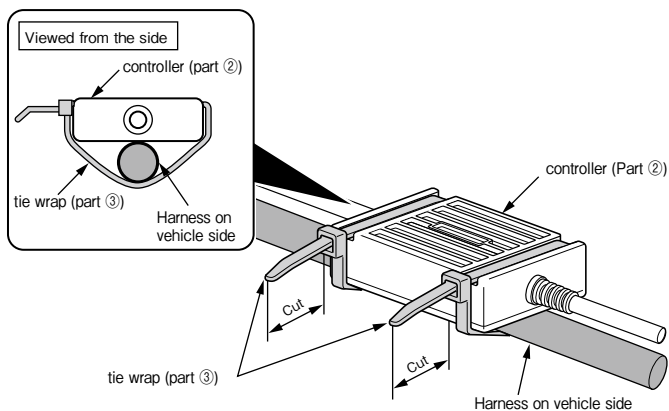

(7) Check that the LED bulb lights up properly and make sure the light beam is not set too high or too low. If the light beam is not properly aligned, make the necessary adjustments.

PIAA

Installation Manual for G3 LED Bulbs (Type HB3/HB4/HIR1/HIR2)

Thank you very much for purchasing PIAA product. Read this instruction manual thoroughly for proper use of the product. After completing your installation, please keep this manual for future reference.

For customers Please forward this manual to the next owner.

For installation service agents Be sure to hand over this instruction manual to the customer after installation.

※ ⚠ CAUTION marks and ⚠ WARNING marks in this manual indicate important notices for installing this product. Be sure to follow these notices in order to ensure safe and reliable work.	⚠ CAUTION Indicates procedures or situations that may cause bodily harm if used improperly.
	⚠ WARNING Indicates items that may cause damage or abnormality to products if used improperly.

Contents

- ① LED bulb (HB3/HB4/HIR1/HIR2 type) [2 pieces]
- ② Controller [2 pieces]
- ③ Tie wrap [6 pieces]
- ④ Hexagon wrench [1 piece]
- ⑤ O-ring (Red) [2 pieces]

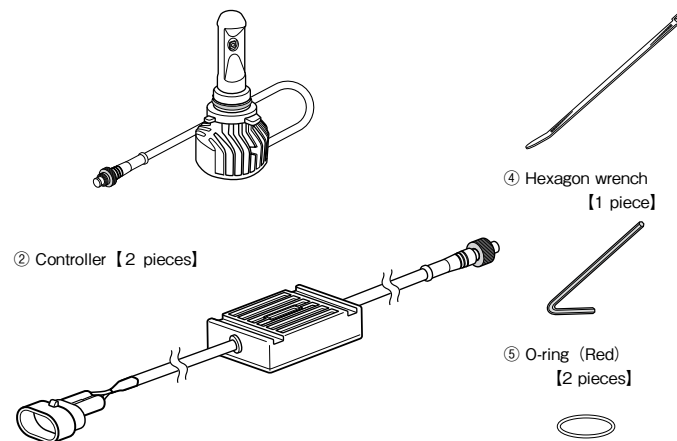

Notice to customers: Carefully read through the instructions before using this product.

- This product is for 12V and 24V vehicles. Check the bulb type before use. Do not mount or use the product for different types.
- This product can be installed in lamps that use a HB3/HB4/HIR1/HIR2 bulb. Before replacing the bulb with the new one, make sure to check the markings on the old bulb. Make sure there is no problem before continuing.
- On some vehicles (including imported models) a warning lamp may go on indicating that the bulb has burned out or some other type of abnormal indication may occur. This phenomenon is common to LED products. In addition, in order for the system to sense that a bulb has burned out, a minute amount of electric voltage continues to flow even when the switch is turned off. Therefore, please be aware beforehand that when the bulb is replaced, the LED bulb may light up slightly but this is not a product malfunction. (The amount of voltage that is consumed when the LED lights up is minimal. The amount is equal to what is used to power the vehicle's clock and will not lead to a sudden drop in battery power.)
- Because LEDs have a different luminescence process from H.I.D. or halogen bulbs, even if the light color is the same it may look different when seen from a human eye. In addition, depending on the lamp setting, the light color may change. (Even when installing a bulb with the same color temperature in a lamp housing, the color variation may vary.)
- With regards to this bulb, turn on the light after switching the engine's ignition to the "ON" position. In the case of hybrid engines, switch the engine's ignition to the "READY-ON" position. (If the engine's ignition indicates "Engine-OFF" or in the case of hybrid vehicles, "READY-OFF", the light may not turn on in some cases. The light will go on normally if the ignition indication reads "Engine-ON" or "READY-ON")
- When using this product in vehicles that have idling stop systems or have weak battery power, the light may fail to light up or may flicker when starting the engine.
- If this product is installed and used in a lamp fitting that has deteriorated after extended use, the functional performance of this product may not have the originally intended effect. As a result, there is a possibility that it may not successfully pass the required automobile inspection. If this is the case, replace it with the original bulb.
- When installing this product on vehicles that have "corner sensors" (sonar), there is a possibility that these type of sensors may not operate properly. Make sure to install the controller approximately 20cm or more away from the sensor.

Precautions for Use

WARNING

- Do not touch the LED bulb directly as it is extremely hot when it is illuminated and also retains considerable heat immediately after turning it off.
- Do not look directly at the lamp for extended periods of time while it is illuminated. This may cause pain to the eyes and may cause adverse effects to your eyesight.
- If there is abnormal vibration or sound when the vehicle is in motion, immediately stop the vehicle in a safe location and inspect the vehicle.
- Do not disassemble or modify the unit in any way. Doing so may cause damage, fire or result in bodily injury.
- Keep the product out of reach of infants. Otherwise infants may swallow or break the product, leading to injury.
- When the lamp is lit, the lens becomes hot. Do not wash the vehicle while the lights are on or immediately after turning them off.

Adjusting the position of the light-emitting section

Use the hexagon wrench (part ④) that is attached and loosen the set screw on the LED bulb (part ①) by turning it half way to a full turn. This will allow you to adjust the metal cap. After adjustment, tighten the setscrew and fix the metal cap in place.

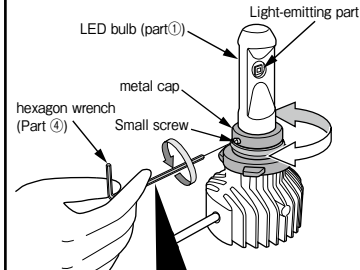

The metal cap will move when the set screw is loosened one half to full turn.

CAUTION

- Do not loosen the set screw more than one full turn because if the set screw is loosened too much it will cause it to come off.
- As shown in the illustration below, the movement range of the metal cap is limited. If the set screw is loosened too much, the metal cap will turn and subsequently exceed the movement range. If the set screw is tightened while in that position, the setting position of the metal and LED bulb will misalign and the set screw will pop out. If this happens, the bulb itself cannot be installed into the lamp unit. Therefore be careful not to over-tighten the set screw.

Truth plan view

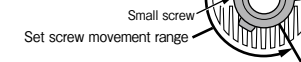

- If you tighten the set screw too strongly when setting it into position it may damage the set screw as well as the LED bulb. Therefore use the short end of the hexagon wrench to carefully tighten it in place.

(4) Connect the LED bulb (part ①) and the controller (part ②).

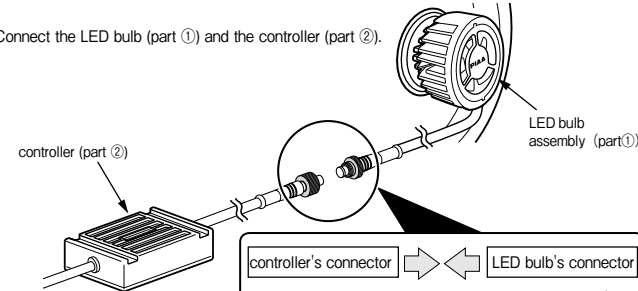

CAUTION

- Insert it straight into the unit according to the arrow mark indicated above the connector, otherwise, it may not illuminate properly.

controller's connector → LED bulb's connector

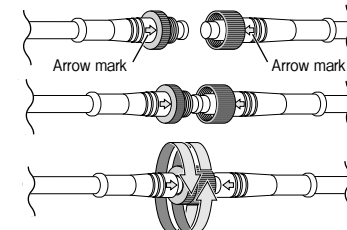

Turn the screw firmly and properly fix it in place.

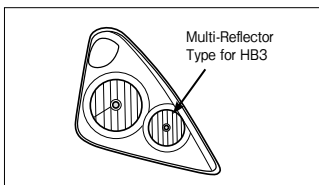
When installing to Multi-Reflector Type for HB3

Install the LED bulb to the lamp.
As shown in the illustration below, line up the light-emitting part of the LED bulb (part ①) with the high beam reflector so it faces sideways. Then check to determine what direction and at what angle it should be rotated and then remove the bulb. Then adjust it using the procedures described in [Adjusting the position of the light-emitting section](#) on page 6

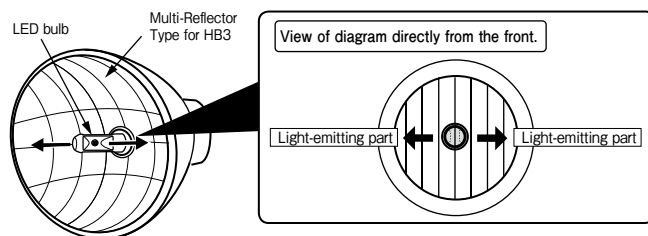
**When installing to fog lamp**

Install the LED bulb to the lamp.
As shown in the illustration below, line up the light-emitting part of the LED bulb (part ①) with the fog lamp reflector so it faces sideways. Then check to determine what direction and at what angle it should be rotated and then remove the bulb. Then adjust it using the procedures described in [Adjusting the position of the light-emitting section](#) on page 6

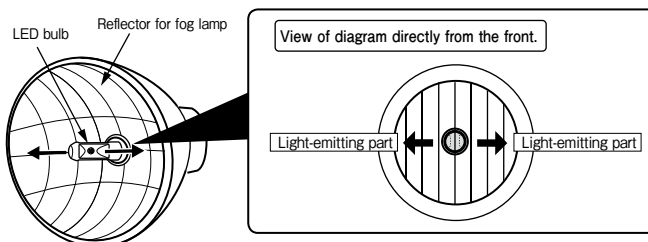
**Precautions for Use****⚠ WARNING**

- Keep the product out of reach of infants. Otherwise infants may swallow or break the product, leading to injury.
- When the lamp is lit, the lens becomes hot. Do not wash the vehicle while the lights are on or immediately after turning them off.

⚠ CAUTION

- When this bulb/lamp is tuned on, there is a possibility that noise interference may influence the radio or other such devices. Please note that this is not a malfunction of any kind.
- During heavy rain or when putting the vehicle through a car wash, condensation may build up inside the lamp due to the difference in temperature inside and outside the lamp. Please note that this will not affect the overall function of the lamp.
- Do not leave the light illuminated while the vehicle is stopped for extended periods of time. (Not to exceed 30 minutes or more).
- Before installing the LED bulb, make sure there is no visible damage or that there is any evidence of it being dropped. If any part is broken or damaged, it may cause it to illuminate abnormally.

Precautions for Replacement**⚠ CAUTION**

- When replacing the LED bulb, make sure the power is turned off and then remove the battery minus (-) terminal before carrying out the replacement procedure. Not doing so may result in not only a fire hazard but possible electrocution or bodily injury. In addition, please use rubber gloves when carrying out this work process.
- As a result of replacing the bulb, the axis of the light may become misaligned. Therefore, after replacement, check the lamp position and make necessary adjustments to the alignment.
- Make sure not to touch the base part or the area that illuminates light. Also, prevent any type of oil or dirt from adhering to the product. If the light is turned on in this condition, it may cause a lighting malfunction.
- Never turn the switch to "ON" when the LED bulb and the bulb connector are not connected.
- Make sure to prevent moisture from adhering to the product. If the light is turned on in this condition, it may cause a lighting malfunction. If moisture is present, let it dry out thoroughly before use.
- Bulb replacement should be done safely on a flat surface where a wide space is available. Before replacement, stop the vehicle engine, apply the emergency brake, place the shift in parking or neutral position, and pull out the key.
- Do not yank on the harness when disassembling. Doing so may damage the harness leading to overheating and potential failure.
- Be careful not to lose the original bulbs by keeping them in a safe place after removal.
- Verify the position of the product as well as the metal base of the connector. Check the proper direction and the install it securely.
- In the case of connector or terminal desorption, hold the connector terminal and straighten it out. Please note that if excessive force is applied to the terminal it may break or it may no longer connect. As a result it may cause damage leading to overheating and potential failure.
- Make sure not to apply excessive force to the light emitting part. If this part is damaged, it may cause a lighting malfunction. Please handle this product with extreme care.

[1] Replacement procedure

- (1) Before starting the installation work, refer to the vehicle's installation manual and verify the place where the bulb will be installed and carry out the installation.
- (2) First verify that the bulb is currently installed on the vehicle. Replace the O-rings as deemed necessary.

HB4 / HIR2 : Black O-ring (The O-ring is installed on the LED bulb)
 HB3 / HIR1 : Red O-ring (Part ⑤)

Procedures for replacing the O-rings

If it is necessary to replace the O-ring, use a tool with the thin, narrow end to remove the O-ring as shown in the illustration on the right. Select the O-ring that matches the bulb type using the list above. Set the new O-ring into the same groove that is provided.

※ When carrying out the replacement process, do not touch the illuminating part of the LED bulb with your bare hands.

- (3) This product requires that the light-emitting section of the LED bulb must be properly adjusted depending on the type of lamp it will be installed on. Verify the type of lamp it will be installed on from the list below. Follow the procedures according to each type of lamp and install the LED bulb to the lamp.

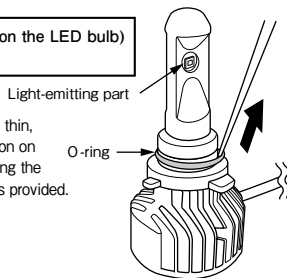

When installing to Projector Type Light

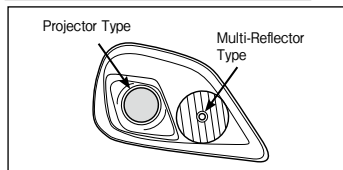

Install the bulb as is without changing the direction of the light-emitting part. (As shown in the illustration below, the light-emitting part of the LED bulb is set sideways.) The direction of the light-emitting part of the LED bulb inside the projector unit is as shown in the illustration below. After completing the installation, confirm that the harness for the LED bulb is protruding downwards.

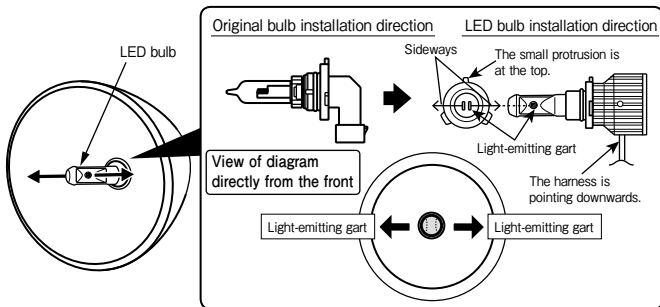

When installing the Multi-Reflector Type for HB4

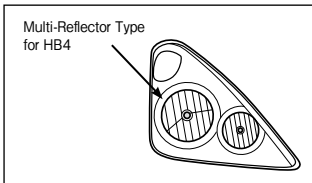

Install the LED bulb to the lamp. As shown in the illustration below, line up the light-emitting part of the LED bulb (part ①) with the angle of the elbow cutline of the low beam reflector. Then check to determine what direction and at what angle it should be rotated and then remove the bulb. Then adjust it using the procedures described in **Adjusting the position of the light-emitting section** on page 6

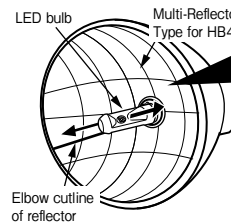

View of diagram directly from the front

The elbow cut-line may vary according to the type of vehicle. Set the light-emitting part in the direction as shown in the diagram below.

