

INSTALLATION INSTRUCTIONS

2¹/₁₆" & 2⁵/₈" PYROMETERS

For EGT models with probe included



2650-1726-00

QUESTIONS:

If after completely reading these instructions you have questions regarding the operation or installation of your instrument(s), please contact Auto Meter Technical Service at 866-248-6357.

You may also email us at service@autometer.com.

Additional information can also be found at <http://www.autometer.com>

Important Pyrometers are sensitive, high accuracy instruments. They must be handled and installed with care to insure proper performance. Carefully read and follow these instructions, and your pyrometer will provide you with a long and accurate life.

Probe Installation

- Begin by installing the Thermocouple in the exhaust. For turbo engines, install the probe 1-2 inches from the turbo exhaust outlet or you may install the probe prior to the turbo. You may consult an engine builder or tuner for recommendations for which probe location is best for you. If installing pre-turbo, removal of the pipe or manifold may be necessary to avoid metal shavings in the turbo. For non-turbo engines, install the probe 1-2 inches from the cylinder head. The probe can be mounted three different ways, so please use the method best suited for your needs.
 - Pre-existing 1/8" NPT Threaded Hole:** Simply screw the threaded fitting into the hole, insert the probe and tighten the nut already on the probe from the factory. Make sure the probe is oriented so the wires do not come in contact with, or become too close to, the manifold or other hot engine parts.
 - Weld Fitting:** Drill a 5/16" hole and weld in the supplied bushing being careful not to distort the bushing. The bushing must be welded and not braised into the manifold or exhaust header. Screw the threaded fitting into the hole, insert the probe and tighten the nut already on the probe. Make sure the probe is oriented so the wires do not come into contact with, or become too close to, the manifold or other hot engine parts.
 - Stainless Clamp Method:** This method is for the applications that require frequent removal of the manifold or the header for service, or just faster and easier installation. Drill a 1/4" diameter hole about 6" down from the junction of the the exhaust pipe to manifold junction. Remove the 1/8" NPT bushing from the probe and replace it with the stainless clamp and set screw collar provided. Undo the clamp and slide the probe into the 1/4" hole in the clamp. Slide the set screw collar onto the probe. Before tightening the collar in position make sure that when inserted, the probe will have it's tip in the middle two-thirds of the exhaust stream. (It is not necessary to go beyond the half way point.) Once screw collar is tightened in the correct position, gently (washer is fragile) push the white ceramic washer over the probe using a 1/4" box end wrench. Push the washer on until it is up against the screw collar. Hold the clamp open when inserting the probe into the 1/4" hole. Re-join the clamp ends and tighten in position so the wires will not get close to the hot manifold/exhaust pipe. See the Illustration below for details.
 - Drill & Tap into Manifold Method:** You may drill a cast iron manifold with a 5/16" letter R (.339) drill bit and follow through with a 1/8" NPT pipe tap.
- With your probe installed plug the wire harness into the gauge, and route the probe end of the harness out to the probe. Pull the large shrink tube back from the screw connections on the probe. Attach the staggered end of the probe harness with the small (No. 6) ring terminals to the probe using the #6 screw and self locking nuts. Attach them Red to Red and Yellow to Yellow. Slide the shrink tube over the staggered connections to protect them, Do not shrink this tube until after the installation is complete, and correct operation is verified. If a heat source is not available the open ends may be closed with wire ties.
- The probe harness is an integral part of the pyrometer calibration. It may not be shortened or lengthened without effecting the gauge calibration. You'll need to determine a suitable location to coil the excess and tie it loosely with a wire tie. (Loosely tying the excess coil prevents embrittlement caused by vibration.) Pass the probe harness through the fire wall using an existing hole or drill a 1 1/32" (.343") diameter hole and use the rubber grommet provided to protect the wire from damage.

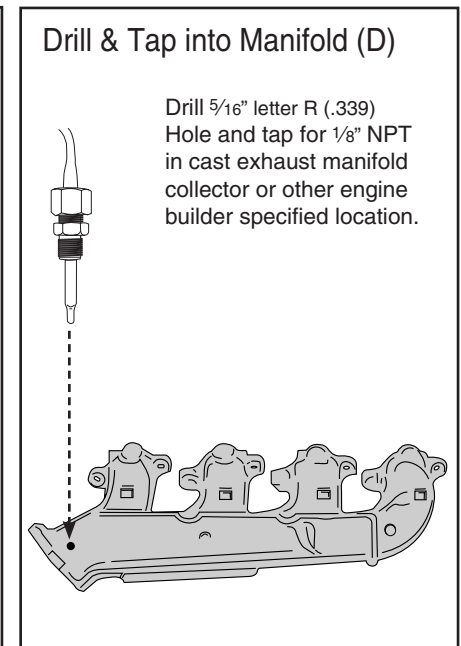
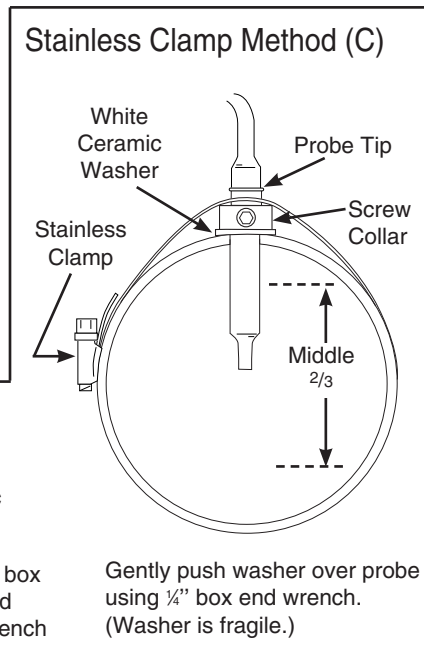
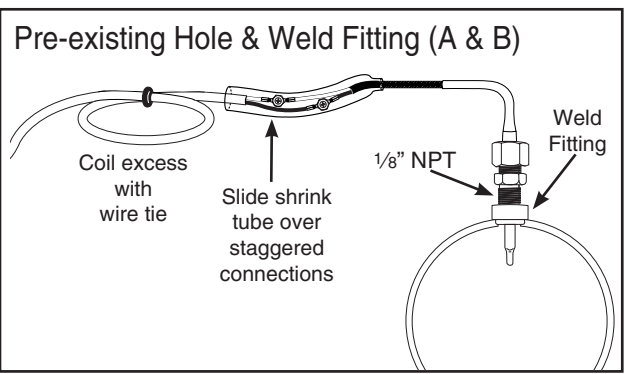

WARNING: Fibers from white ceramic washer may irritate skin. Wash hands after handling washer.

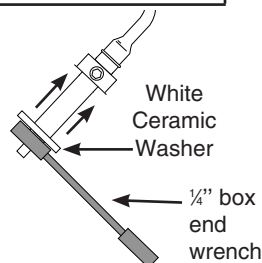

Probe Installation

1. Disconnect the negative (-) battery cable.
2. The 2 $\frac{5}{8}$ " gauges may be mounted in a 2 $\frac{5}{8}$ " diameter hole. The 2 $\frac{1}{8}$ " gauges may be mounted in a 2 $\frac{1}{8}$ " diameter hole. The hole may be either a hole in the dash, a gauge panel or an Auto Meter Gauge Pod. (It is best to connect all wiring to the gauge before mounting it into the gauge hole.)
3. Install light in back of gauge and connect white wire to dash lighting circuit or to any 12-volt source. Connect BLACK light socket wire to good ground. Connect RED gauge wire to switched 12V source. Connect BLACK gauge wire to an **ENGINE GROUND**.
4. Verify that all wire connections are correct and secure. Secure gauge in hole with mounting bracket supplied.
5. Reconnect the negative (-) battery cable.

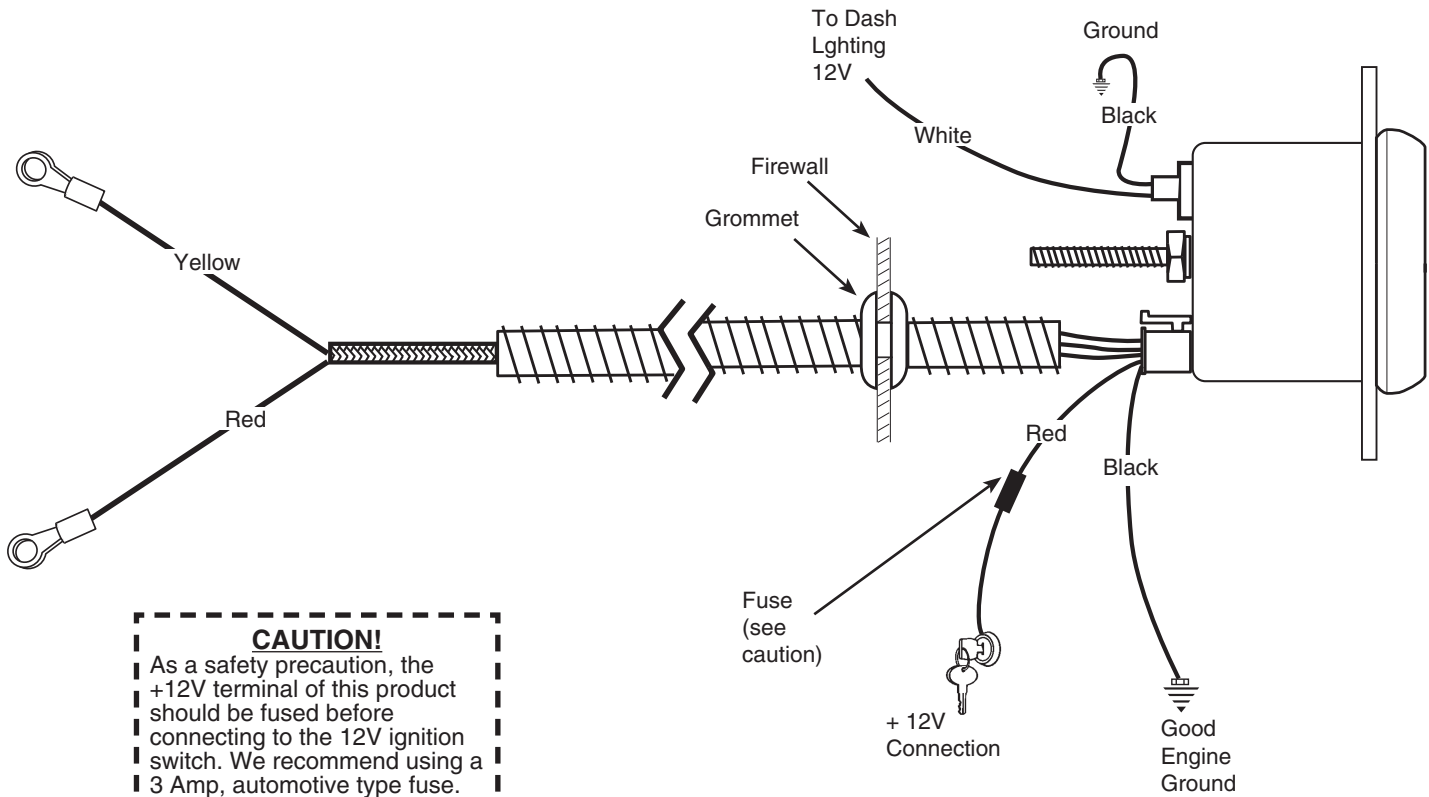

CAUTION!
As a safety precaution, the +12V terminal of this product should be fused before connecting to the 12V ignition switch. We recommend using a 3 Amp, automotive type fuse.

SERVICE

For service send your product to Auto Meter in a well packed shipping carton. Please include a note explaining what the problem is along with your phone number. If you are sending product back for Warranty adjustment, you must include a copy (or original) of your sales receipt from the place of purchase.

12 MONTH LIMITED WARRANTY

Auto Meter Products, Inc. warrants to the consumer that all Auto Meter High Performance products will be free from defects in material and workmanship for a period of twelve (12) months from date of the original purchase. Products that fail within this 12 month warranty period will be repaired or replaced at Auto Meter's option to the consumer, when it is determined by Auto Meter Products, Inc. that the product failed due to defects in material or workmanship. This warranty is limited to the repair or replacement of parts in the Auto Meter instruments. In no event shall this warranty exceed the original purchase price of the Auto Meter instruments nor shall Auto Meter Products, Inc. be responsible for special, incidental or consequential damages or costs incurred due to the failure of this product. Warranty claims to Auto Meter must be transportation prepaid and accompanied with dated proof of purchase. This warranty applies only to the original purchaser of product and is non-transferable. All implied warranties shall be limited in duration to the said 12 month warranty period. Breaking the instrument seal, improper use or installation, accident, water damage, abuse, unauthorized repairs or alterations voids this warranty. Auto Meter Products, Inc. disclaims any liability for consequential damages due to breach of any written or implied warranty on all products manufactured by Auto Meter.

FOR SERVICE SEND TO: AUTO METER PRODUCTS, INC. 413 W. Elm St., Sycamore, IL 60178 USA (866) 248-6357
Email us at service@autometer.com
<http://www.autometer.com>



The Super Bezel is a registered trademark of Auto Meter Products, Inc.